

JUKI®

2-Needle, 2/3/4-Thread Overlock Sewing Machine

MO-2000QVP

INSTRUCTION MANUAL

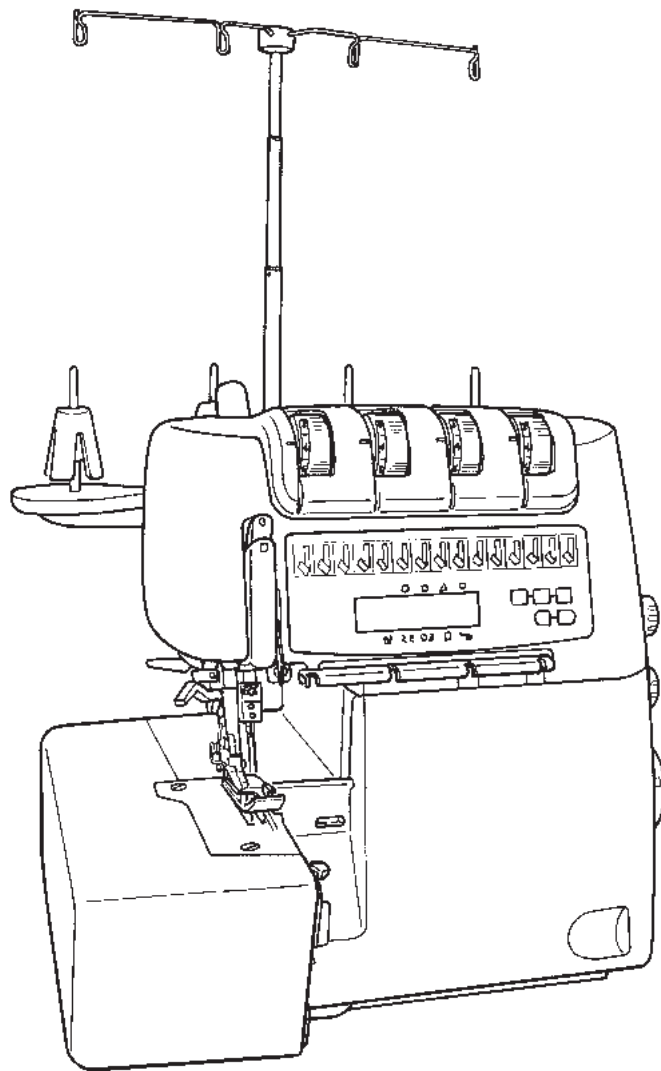

IMPORTANT:

Read all safety regulations carefully and understand them before using your sewing machine.
Retain this instruction manual for future reference.

“IMPORTANT SAFETY INSTRUCTIONS”

When using an electrical appliance, basic safety precautions should always be followed, including the following: Read all instructions before using this sewing machine.

“DANGER ___ To reduce the risk of electric shock:”

1. The appliance should never be left unattended when plugged in.
2. Always unplug this appliance from the electric outlet immediately after using and before cleaning.

“WARNING ___ To reduce the risk of burns, fire, electric shock, or injury to persons:”

1. Do not use the appliance as a toy. Caution is advised when the appliance is used by children, or near children. This sewing machine can be used by children aged from 8 years and above and persons with reduced physical, sensory or mental capabilities or lack of experience and knowledge if they have been given supervision or instruction concerning use of the sewing machine in a safe way and understand the hazards involved. Children shall not play with the sewing machine. Cleaning and user maintenance shall not be made by children without supervision.
2. Use this appliance only for its intended use as described in this manual. Use only attachments recommended by the manufacturer as contained in this manual.
3. Never operate this appliance if it has a damaged cord or plug, if it is not working properly, if it has been dropped or damaged, or dropped into water. Return the appliance to the nearest authorized dealer or service center for examination, repair, electrical or mechanical adjustment.
4. Never operate the appliance with any air openings blocked. Keep ventilation openings of the sewing machine and foot control free from the accumulation of lint, dust, and loose cloth.
5. Keep fingers away from all moving parts. Special care is required around the sewing machine needle.
6. Always use the proper stitch plate. The wrong plate can cause the needle to break.
7. Do not use bent needles.
8. Do not pull or push fabric while stitching. It may deflect the needle causing it to break.
9. Do not carry out sewing with a marking pin stuck in the material since doing so can cause knife/needle breakage. In addition, do not attempt to cut anything other than fabric and thread with the upper/lower knives.
10. Switch the sewing machine off “O” when making any adjustments in the needle area, such as threading needle, changing needle, threading looper, or changing presser foot and the like.
11. Always unplug the machine from the electrical outlet when removing covers, when covers are opened to thread the loopers, when lubricating or when making any other user servicing adjustments mentioned in the instruction manual.
12. Never drop or insert any object into any opening.
13. Do not use outdoors.
14. Do not operate where aerosol (spray) products are being used or where oxygen is being administered.
15. To disconnect, turn all controls to the off “O” position, then remove plug from outlet.
16. Do not unplug by pulling on cord. To unplug, grasp the plug, not the cord.
17. Basically, the machine should be disconnected from the electricity supply when not in use.
18. If the power cord of this appliance is damaged, it must be replaced with a special cord by your nearest authorized dealer or service center.
19. (Except USA/Canada) This machine is provided with double insulation.
Use only identical replacement parts. See instructions for servicing Double-Insulated machine.

“SERVICING DOUBLE-INSULATED PRODUCTS

(Except USA / Canada)”

In a double-insulated product, two systems of insulation are provided instead of grounding. No grounding means is provided on a double-insulated product nor should a means for grounding be added to the product. Servicing a double-insulated product requires extreme care and knowledge of the system and should only be done by qualified service personnel. Replacement parts for a double-insulated product must be identical to those parts in the product. A double-insulated product is marked with the words DOUBLE INSULATION or DOUBLE INSULATED.

The symbol  may also be marked on the product.

“SAVE THESE INSTRUCTIONS”

“This overlock sewing machine is intended for household use only.”

Congratulations on your purchase of a JUKI sewing machine.



Please be sure to read safety precautions in “To use the sewing machine safely” in the Instruction Manual before use to fully understand the functions and operating procedures of the sewing machine so as to use the sewing machine for a long time.

After you have read the Instruction Manual, please be sure to keep it together with the warranty so that you can read it whenever necessary.





To use the sewing machine safely

Marks and pictographs included in the Instruction Manual and shown on the sewing machine are used so as to ensure safe operation of the sewing machine and to prevent possible risk of injury to the user and other people.

Warning marks are used for different purposes as described below.

 WARNING	Indicates that there is a possible risk of death or serious injury if this mark is ignored and the sewing machine is used in a wrong manner.
 CAUTION	Indicates the operation, etc. which can cause a possible risk of personal injury and/or physical damage if this mark is ignored and the sewing machine is used in a wrong manner.

Pictographs mean the following:

	Danger warning which is not specified		There is a risk of electrical shock		There is a risk of fire		There is a risk of injury to hands, etc.
	Prohibited matter which is not specified		Disassembly/alteration is prohibited		Do not place fingers under the needle		Do not pour oil, etc.
	Generally required behavior		Disconnect the power plug				

! WARNING

For the combination of the material and the thread and needle, in particular, refer to the explanation table in “Replacement of the needle”.

If the needle or thread does not match the material used such as in the case that an extra heavy-weight material (e.g., denim) is sewn with a thin needle (#11 or higher), the needle can break resulting in an unexpected personal injury.

Other precautions

- Do not put the sewing machine under the direct sunlight or in a humid place.

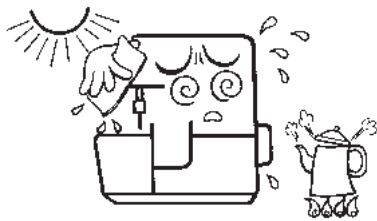

- Do not wipe the sewing machine with solvent such as thinner.

When the sewing machine is soiled, put a small quantity of neutral detergent on a piece of soft cloth and carefully wipe off the sewing machine with it.

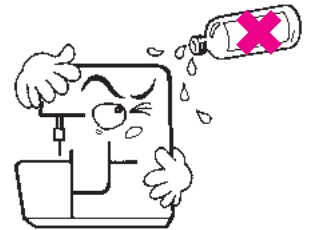

Be aware that the following state can take place since the sewing machine incorporates semi-conductor electronic parts and precise electronic circuits.

- Be sure to use the sewing machine in the temperature range from 5°C to 40°C. If the temperature is excessively low, the machine can fail to operate normally.

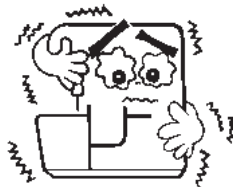

* The operating temperature of the sewing machine is between 5°C and 40°C. Do not use the sewing machine under the direct sunlight, near the burning things such as a stove and candle, or in a humid place. By so doing, the temperature in the interior portion of the sewing machine can rise or the coating of the power cord can melt, causing fire or electrical shock.

Contents

Safety regulations	1-3
Contents	4
Details of the machine	5-7
• Accessories	6
• Thread stand	7
Preparing the machine / Using the machine ·	7,8
• Attaching the foot control	7
• Waste collector	8
• Thread, cones, spools	8

Using the machine

• Main Power/ light switch	9
• Looper cover	9
• Handwheel	9
• Two step presser foot lifter	10
• Changing the presser foot	10
• Upper knife is deactivated	10
• How to use the presser foot	11
• Inserting needles / Needles and Threads	11, 12

Adjustments and settings

• Stitch length	13
• Cutting width	13
• Differential feed	14
• Gathering	15
• Roll hemming	15
• Presser foot pressure	15

Setting/ Practical sewing

• Preparation/Tips	16
--------------------------	----

Threading 4/3 Thread OL

• Lower looper	17
• Upper looper	18
• Right needle	19
• Left needle	20
• How to use the looper threader	21
Trial sewing	22
Thread tension	23

Practical Sewing-Overlock

• Sewing in tape	24
• Carrying out hemming and narrow overlocking	24
• Wrapped overlocking with three threads ···	25
• 2-/3-thread changeover attachment	25
• Cover stitch with three threads (flatlock) ···	26
• Thread breakage during sewing	26
• Unpicking seams	26
Securing thread ends at the beginning and end of sewing	27, 28
LCD indication	29-32
Stitch chart	33

Maintenance

• Cleaning and lubricating	34
• Replacing the knife	34
Trouble shooting guide	35, 36
Technical data	37
Optional accessories	37

Details of the machine

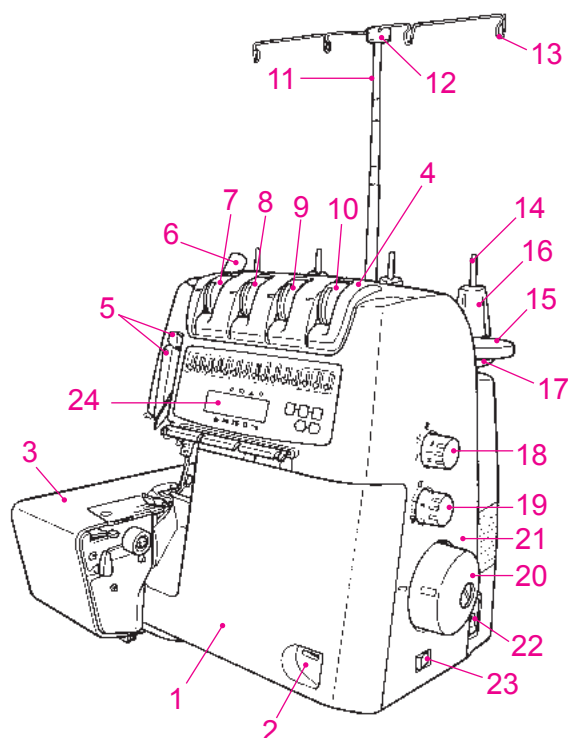

Details of the machine

1. Looper cover with built in knife guard
2. Looper cover opening indent
3. Cloth plate
4. Top cover
5. Thread take-up cover
6. Presser foot pressure regulating knob
7. Left needle thread tension dial
8. Right needle thread tension dial
9. Upper looper thread tension dial
10. Lower looper thread tension dial
11. Retractable support rod
12. Thread guide support
13. Open thread guide
14. Spool holder pin
15. Foam pad
16. Anti - vibration cone
17. Thread stand
18. Stitch length adjustment dial
19. Differential feed adjustment dial
20. Handwheel
21. Front cover
22. Machine socket
23. Main Power/Light switch
24. LCD screen

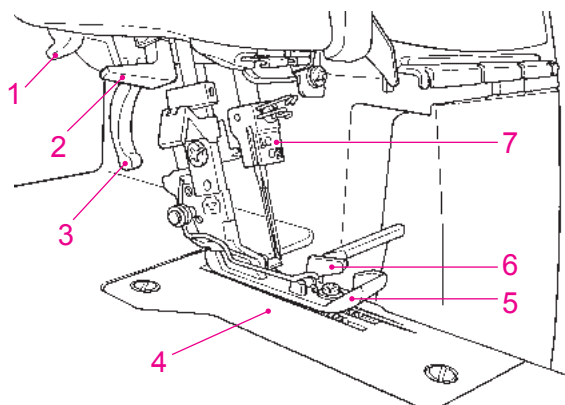

Details of the machine

1. Thread cutter
2. Automatic needle threader
3. Presser foot lifter
4. Stitch plate
5. Presser foot
6. Upper knife
7. Needle clamp

Details of the machine



Caution:

Be sure to turn off the power switch before opening the looper cover.

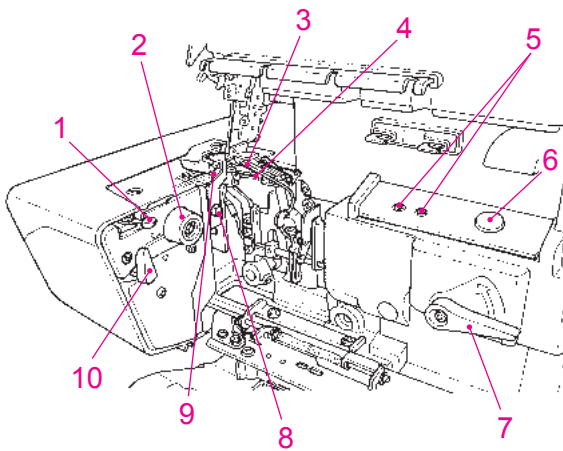

View with looper cover open

1. Selection lever for overlocking or roll hemming
2. Cutting width adjusting dial
3. Upper looper
4. Lower looper
5. Threading hole
6. Air-control pushbutton
7. Threading changeover lever
8. Upper knife fixing screw
9. Lower knife
10. Upper knife changeover knob

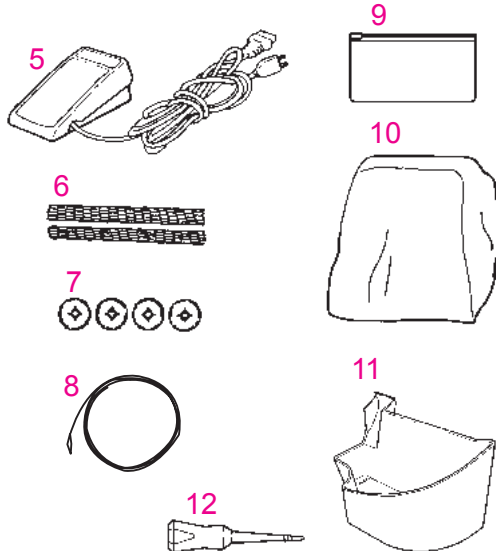
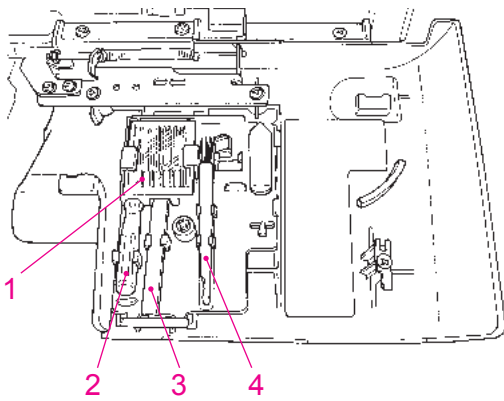

Accessories

1. Needle set 130/705H (SCHMETZ)
2. Screwdriver
3. Tweezers
4. Brush/needle inserter
5. Electronic foot control
6. Nets
7. Spool caps
8. Looper threader
9. Accessory bag
10. Dust cover
11. Waste collector
12. Oiler

Details of the machine

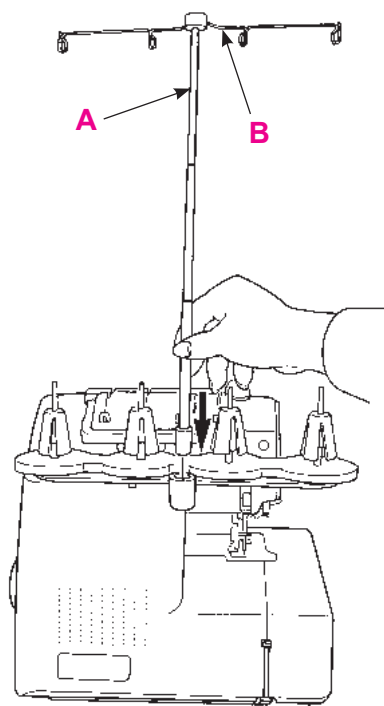

Thread stand

Push the support rod firmly into the socket on the back of the machine.

Raise the support rod (A) fully, turning slightly until the position catches engage. Position the thread guide (B) on the thread stand so that the arrow is to the front.

Preparing the machine / Using the machine

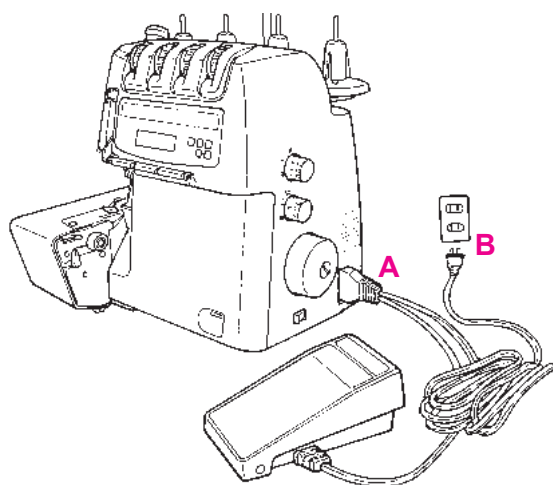

Attaching the foot control

Plug foot control into the machine socket (A) and then into main socket (B). The foot control regulates the sewing speed. The sewing speed can be adjusted by increasing or decreasing the pressure on the foot control.

⚠ "WARNING"

This appliance has a polarized plug (one blade wider than the other).

To reduce the risk of electric shock, this plug is intended to fit in a polarized main socket only one way.

If the plug does not fit fully in the polarized main socket, reverse the plug. If it still does not fit, contact a qualified electrician to install the proper polarized main socket. Do not modify the plug in any way. (for USA, Canada only)

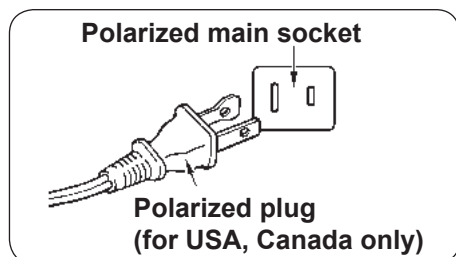

Preparing the machine / Using the machine

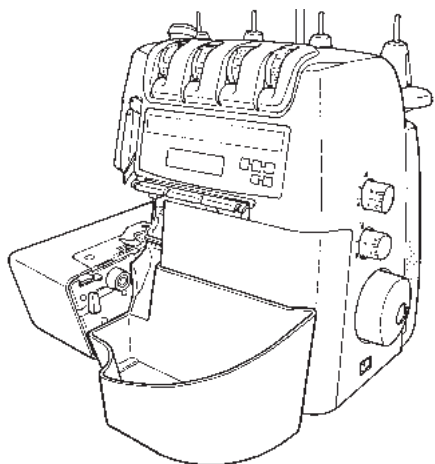

Waste collector

Clip the waste collector into the opening on the looper cover. It catches the cut-off fabric as you sew, keeping your working area neat and tidy.

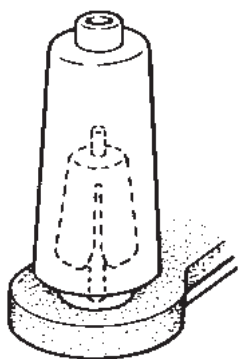

Thread / cones / spools

The anti-vibration cone should be used with the wider edge at the bottom on the spool holder pin when sewing with cones.

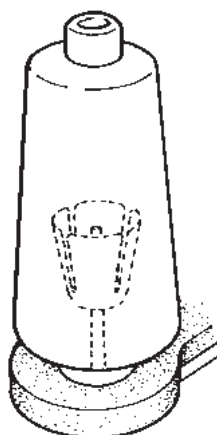

Large spools

If large industrial spools are used, position the anti-vibration cone upside down on the spool holder pin, i.e. with the wider edge at the top.

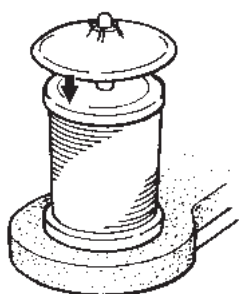

Household spools

Remove the anti-vibration cones. Place spools on spool holder pins and push the spool caps on with the rounded side downwards.

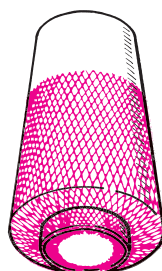

Thread net

If the threads slip and get twisted, cover the looper spools with the net supplied in the accessory bag.

Using the machine

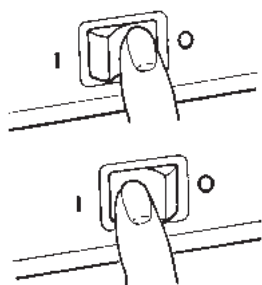

Main Power/light switch

The main power/light switch is conveniently placed on the handwheel side of the machine in front of the socket.

0 = Off

I = On with light

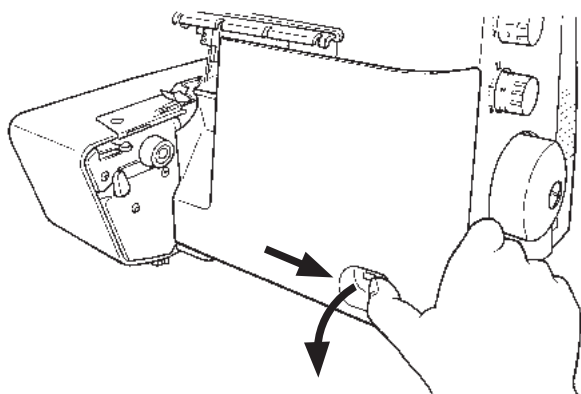

Looper cover

To open, press to the right with your thumb in the indent provided and tilt the cover towards you. To close push it up and press lightly to the right. The cover engages automatically.

Safety device:

The sewing machine is equipped with a safety device in order to prevent malfunction. In any of the following cases, the safety device works to prevent the sewing machine from running.

- * When the looper cover is opened
- * When the cloth plate is opened
- * When the presser foot is raised

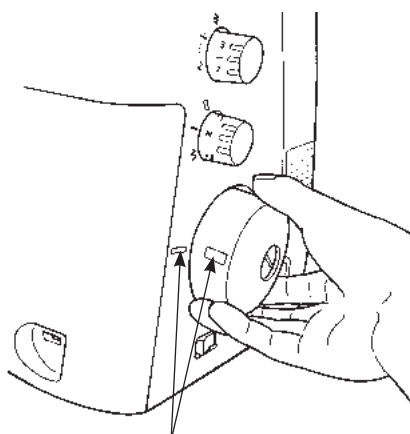

Handwheel

The handwheel turns forward, i.e. in the same direction as on a household sewing machine.

- * The needle is brought to its upper end by aligning the "■" marking on the side of the front cover with the "□" marking on the handwheel.

Using the machine

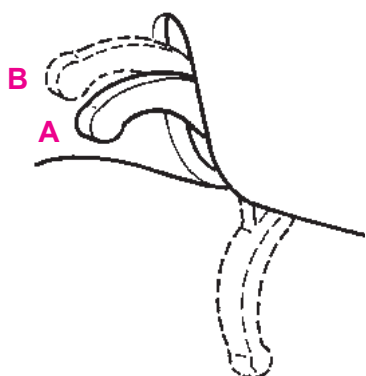

Two step presser foot lifter with integrated front foot lift

To raise the presser foot, lift the presser foot lever on the rear of the machine, until it engages (A). It can be raised again to the maximum height and held in this position to provide more space between presser foot and stitch plate (B).

When the foot is raised (A and B), the front of the foot is automatically lifted.

Note:

When the presser foot is raised, all the tensions are released making it easier to thread the machine.

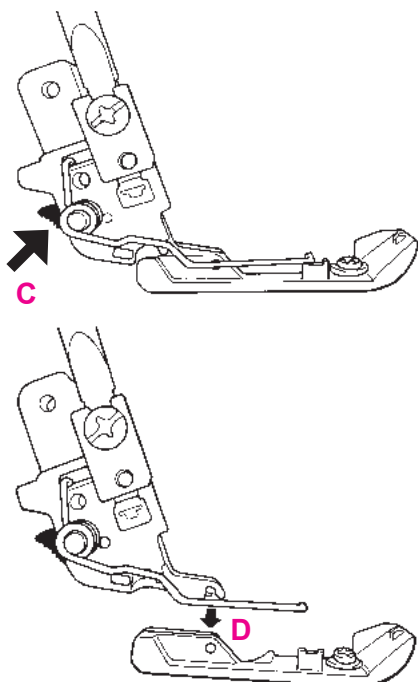

Changing the presser foot



Switch the machine off (power switch "0") and deactivate the upper knife.

- Raise the presser foot.
- Turn handwheel towards you until needles are fully raised. Match the matching up marks on handwheel and side cover.

Press the catch (C) to release the presser foot from the clamp. Raise the presser foot shank to the highest position (B) and remove the presser foot to the left. To attach the presser foot, place it under the shaft. The groove in the shaft should line up exactly with the presser foot pin (D). Lower the presser foot lifting lever and check that the groove in the shank should line up exactly with the presser foot pin (D). If it is not lined up, press the catch (C) to line up.

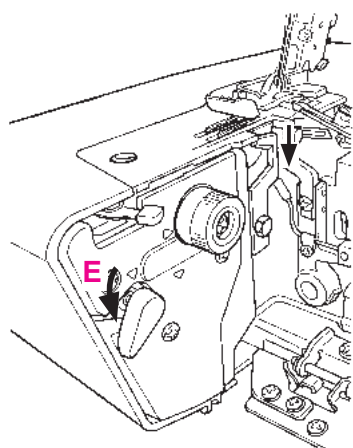

To carry out sewing without cutting the material (the upper knife is deactivated)



Turn off the power switch before deactivating the upper knife.

1. Lower the upper knife changeover knob in the direction of the arrow.
2. Check to be sure that the knife is lowered.

Caution:

To activate the upper knife, bring the upper knife changeover knob at position E. Turn the handwheel by two revolutions by hand.

Using the machine

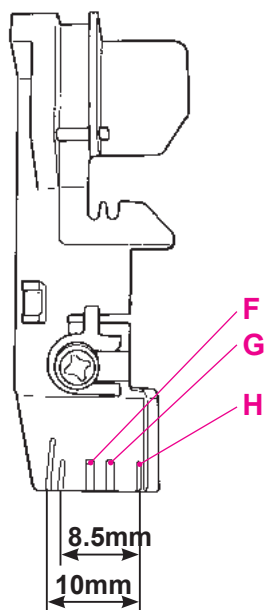

How to use the presser foot

Use the marker on the presser foot as a guide when placing the material under the presser foot.

(F) Left needle position

(G) Right needle position

(H) Knife position (when the lower knife adjusting knob is set at scale mark "1.5")

The knife position represents the position at which the material is cut.

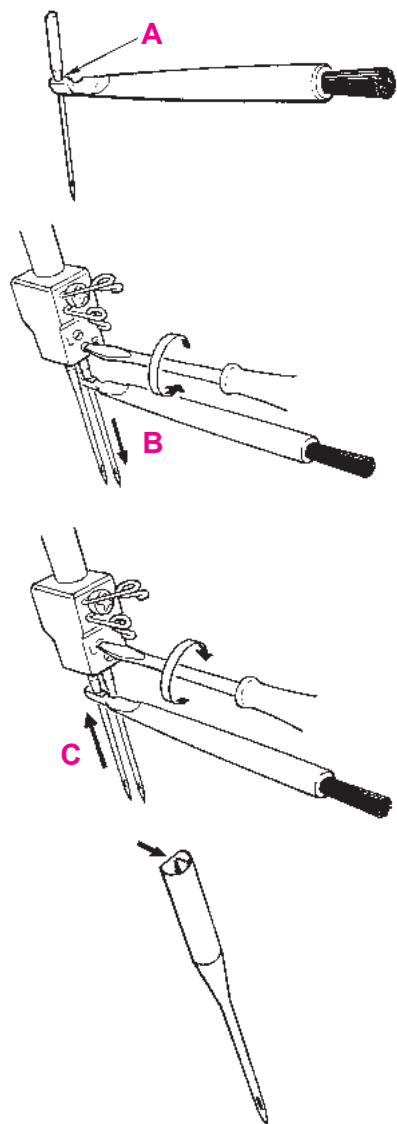

Inserting the needles

Needles can be inserted quickly and easily with the practical needle inserter (A).

Switch the machine off (Power switch to "0")

Disconnect machine from electricity supply.

Turn handwheel towards you until needles are fully raised. Match the matching up marks on handwheel and side cover.

Lower the presser foot.

Using the small screwdriver, loosen the needle setscrews and remove the needles (B).

Place the right-hand needle, flat side towards the back, into the hole of the needle inserter and insert the needle as far as possible into the needle clamp.

Tighten the setscrew lightly and then insert the left-hand needle in the same way and tighten both setscrews (C).

Needle and thread

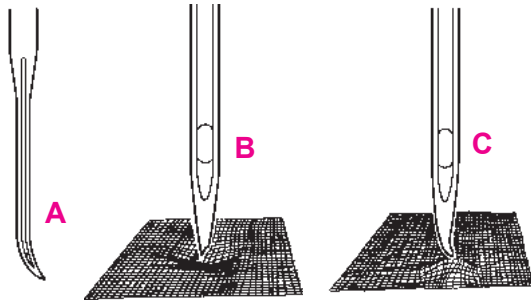

Needles

Needles must be in perfect condition.

Problems can occur if needles:

- A** are bent.
- B** are damaged or blunt.
- C** have hooked points.

Needle and thread

The needle size used depends on the thread. The needles should be in accordance with thread used.

When sewing, the thread is fed through the long groove in the needle. If the needle is too fine, the thread does not fit into the groove and stitches will be skipped.

Use needles No. 70 - 90.

* It is recommended to use JLx2 needle, especially when sewing thick materials, overlapped section, etc, with overlock machine.

Thread/decorative threads

Sewing and special overlock threads are manufactured in a wide variety of types, weights and combination of fibres. It is worth investing in good quality threads for perfect sewing results. Decorative threads specially made for overlockers (available on cones) are also becoming widely available. We recommend following the basic guidelines when using special threads on your overlocker:

- Purchase threads on cones or spools which are produced exclusively for overlocking.
- When using normal spools, use the spool caps (in accessory bag).
- Only use decorative threads in the loopers. The thread must move easily and without resistance through the thread guides and looper eyes.
- The thicker the thread, the longer the stitch length (3-4).
- The thicker the thread, the looser the tensions.
- Sew slowly when using decorative threads. Pull the thread chain gently to the rear when starting to sew.

Always test sew decorative threads before starting to sew your work.

Thread, needle, application table

Thread	Needles	Where	Application
All purpose overlock thread 120/2 (polyester)	70-90	Needles and looper threads	For all overlock.
Polyester-continuous filaments		Loopers only	Neatening edges
Woolly nylon		Loopers only	Soft seams in knits, rolled hems.
Spun Polyester	80-90	Needles and looper threads	Seams in all fabrics.
Embroidery/darning and decorative threads	70-90	Loopers only	Neatening edges, rolled hems.

Adjustments and settings

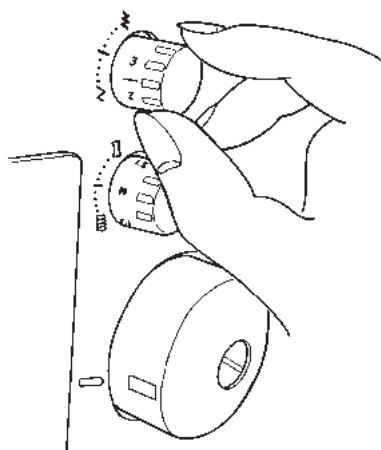

Stitch length

It can be adjusted while sewing.

The stitch length is infinitely variable from 1-4mm. Most overlock work is done with a basic setting of 2.5mm.

For roll hemming or narrow overlocking, it is best to set the dial at “1 to 1.5”.

For blind stitch which requires the “use of separately-available presser foot”, set the dial at “4”.

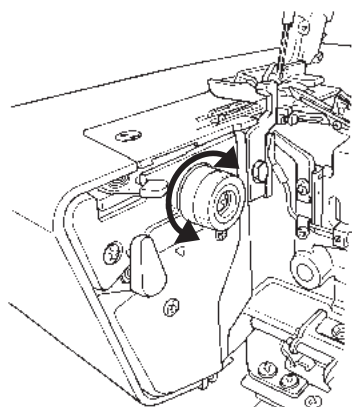

Cutting width



**Switch the machine off (Power switch to “0”)
Disconnect machine from electricity supply.**

- Raise the upper knife.
- Turn cutting width adjustment dial in the desired direction.
- Lower upper knife.

1 = 3–5 mm seam width

2 = 4–6 mm seam width

3 = 5–7 mm seam width

4 = 6–8 mm seam width

5 = 7–9 mm seam width

The position of the lower knife determines the width of the seam.

Reduce the cutting width if the edges of fine fabric curl up when being sewn (A).

Increase the cutting width if the loops seem to be too loose (B).

A

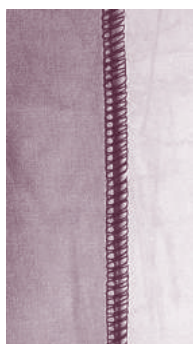

B

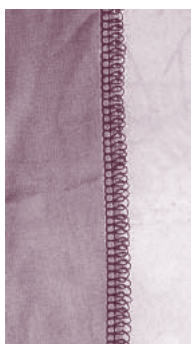

WARNING



Do not carry out sewing with a marking pin stuck in the material. In addition, do not attempt to cut anything other than fabric and thread with the upper/lower knives. Be aware that doing so can cause needle break or personal injury.

Adjustments and settings

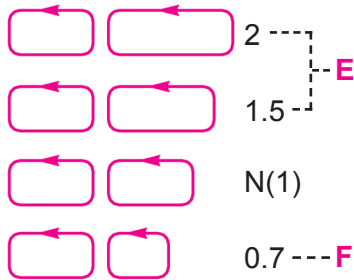
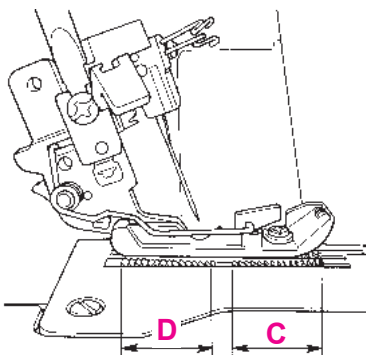
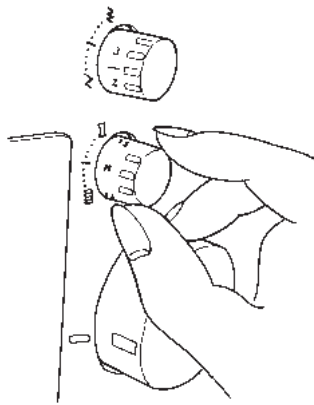

Differential feed

There are two feed dogs one front (C) and one rear (D). The two feed dogs move independently and the distance each feed dog travels during one complete movement can be adjusted. The differential feed prevents fluting or waving in knitted or stretch fabrics and movements between the layers of fabric. It also ensures pucker-free seams in smooth fabric such as nylon or closely woven fabric.

Perfectly flat seams in knits or stretch fabrics.

The distance travelled by the front feed dog should be greater than that of the rear feed dog. The front feed dog, therefore, feeds an amount of fabric which the rear feed dog can take up behind the needle without stretching the fabric. (E)

Pucker - free seams in nylon or closely woven fabrics.

The distance travelled by the rear feed dog should be greater than that of the front feed dog. The front feed dog, therefore, holds the fabric back so that the rear feed dog can take it up behind the needle without any puckering. (F)

Adjusting the differential feed

The differential feed can be adjusted by simply turning the differential feed adjustment dial in the direction desired. Always make a trial run. The differential feed is infinitely variable and can be adjusted while sewing.

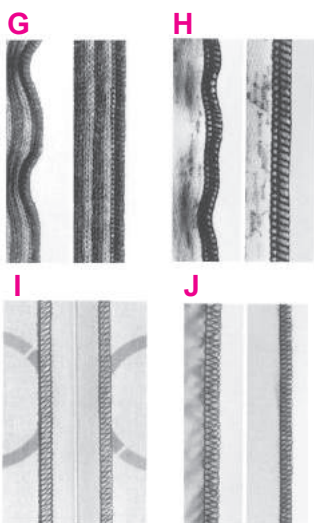

Adjusting the differential feed

Simply turn the dial in the direction desired for fully variable adjustment while sewing. Test sew.

	Effect	Fabric
2	Wave-free seams (G)	Thick wool knits, hand knitted articles, very stretchy fabrics
1.5	Wave-free seams (H)	Cotton, silk, synthetic jersey, sweatshirt fabrics and fine knits
N	Normal feed (I)	Woven fabrics
0.7	No puckering (J)	Fine nylon jersey, closely woven fabrics, lining fabric satin, poplin

Adjustments and settings

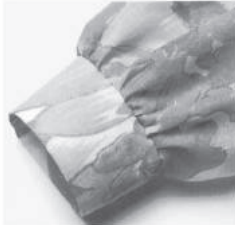

Gathering

Using the differential feed, a single layer of fabric can be gathered before sewing it to the garment.

For example, sleeve heads and lower edges, yokes, lace edging or frills.

Adjustment:

- Stitch: 4-thread overlock
- Differential feed: 2
- Stitch length: 3-4
- Cutting width: 2-3

Increase the needle thread tension (6-8) for a tighter gather.

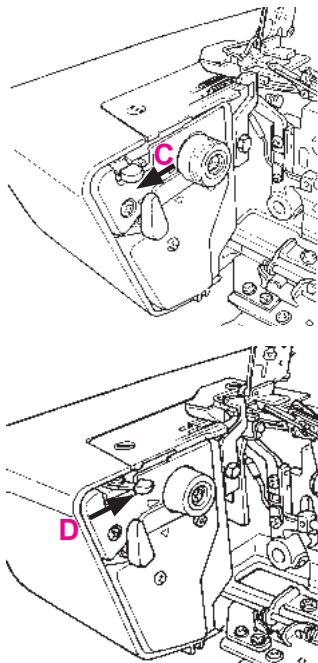

Roll hemming

- Turn the handwheel towards you until the needles are fully raised.
- For roll hemming, pull the overlocking width changeover knob toward you and check that the overlocking claw retracts. (C).
- For overlocking, push the overlocking width changeover knob away from you to check that the overlocking claw projects. (D).

The roll hemmer is fully integrated in the machine. The edge of the fabric will be automatically rolled over, producing a very narrow, fine seam or hem.

Roll hemming is ideal for finishing edges on all fine fabrics, such as evening clothes, lingerie, scarves, frills and also for curtains and napkins.

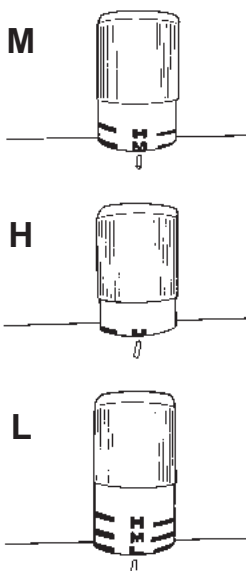

Presser foot pressure

The presser foot pressure is factory adjusted to a medium setting.

Align the marker line on the presser foot pressure regulating knob with the upper end of the top cover.

Position of knob for normal pressure

(M) = Medium.

More pressure: for thick or stiff fabrics such as denim, tweed, firm linen (H) = High.

Less pressure: for light-weight or sheer fabrics and knits (L) = Low.

Threading preparations / Tips

1. Extend the retractable support rod fitted with open thread guide as far as it goes.
2. Raise the presser foot. (Tension disk opens.)
3. Open the looper cover.
4. Turn the power on.

Threading sequence

The thread guides can be threaded in any sequence.
The threading sections are color coded correspondingly.

- Lower looper thread (red markings)
- ▲ Upper looper thread (purple markings)
- Right needle thread (green markings)
- ◆ Left needle thread (beige markings)

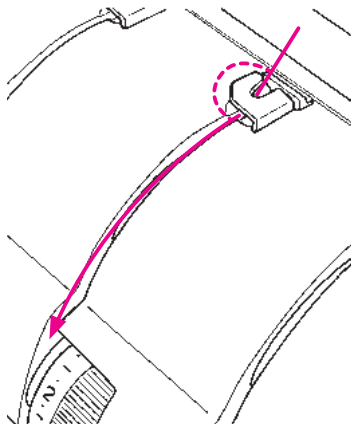

Threading the thread guide No. 1

Bring down the thread which is put on the retractable support rod to thread the thread guide No. 1 from its left side. Then, route the thread downward to bring it toward you.

Threading 4/3 Thread OL

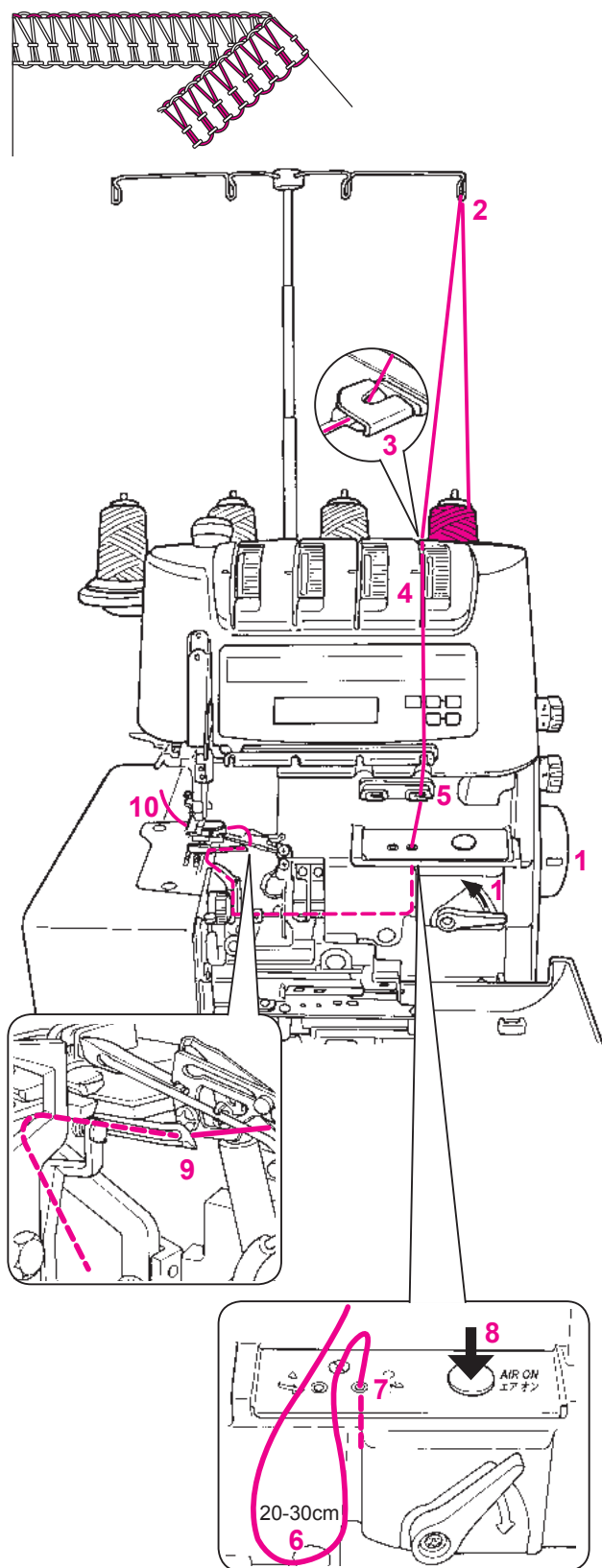

Lower looper thread, red markings

Place the spool on the spool holder pin as illustrated.

(1) Raise the threading changeover lever in the direction of the arrow.

Turn the handwheel toward you until it clicks.

(2) Thread the thread guide which is located just above the spool from back to front.

(3) Thread the thread guide No. 1.

(4) Pull the thread by both hands and thread the thread guide.

(5) Thread the thread guide.

(6) Pull out the thread by 20 to 30 cm to let it sag inside the looper cover.

(7) Pass the top end of thread through threading hole by 1 to 2 cm.

(8) Press the air-control pushbutton.

(9) Check to be sure that the thread comes out from the top end of the lower looper.

(10) Bring the pulled-out thread down from above the upper looper to route it under the presser foot and pull it out from its rear.

Note:

If the upper or lower looper thread breaks during sewing, re-threading is necessary.

Remove both the broken and unbroken looper threads. Then, set the threading lever to the threading side to carry out threading of the upper and lower loopers.

Threading 4/3 Thread OL

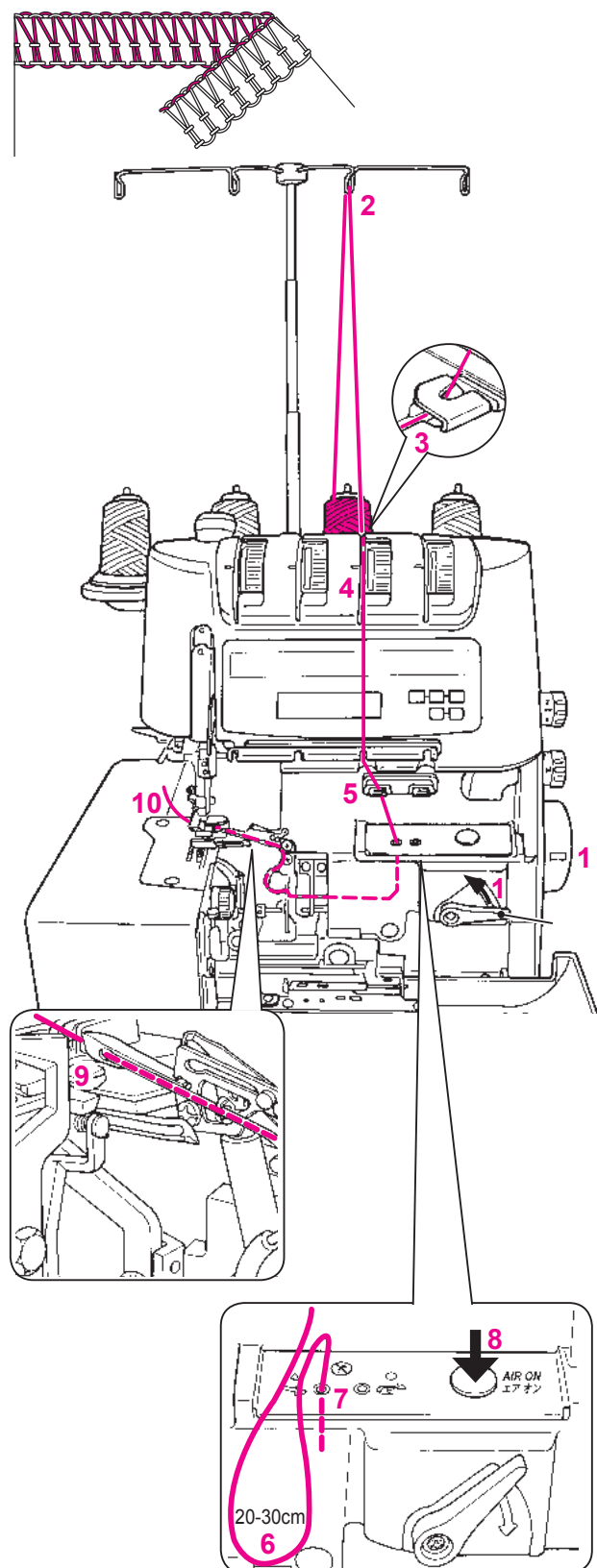

Upper looper thread, purple markings

Place the spool on the spool holder pin as illustrated.

- (1) Raise the threading changeover lever in the direction of the arrow.
Turn the handwheel toward you until it clicks.
- (2) Thread the thread guide which is located just above the spool from back to front.
- (3) Thread the thread guide No. 1.
- (4) Pull the thread by both hands and thread the thread guide.
- (5) Thread the thread guide.
- (6) Pull out the thread by 20 to 30 cm to let it sag inside the looper cover.
- (7) Pass the top end of thread through threading hole by 1 to 2 cm.
- (8) Press the air-control pushbutton.
- (9) Check to be sure that the thread comes out from the top end of the upper looper.
- (10) Pull the thread by approximately 10 cm to route it under the presser foot and pull it out from its rear.

Threading 4/3 Thread OL

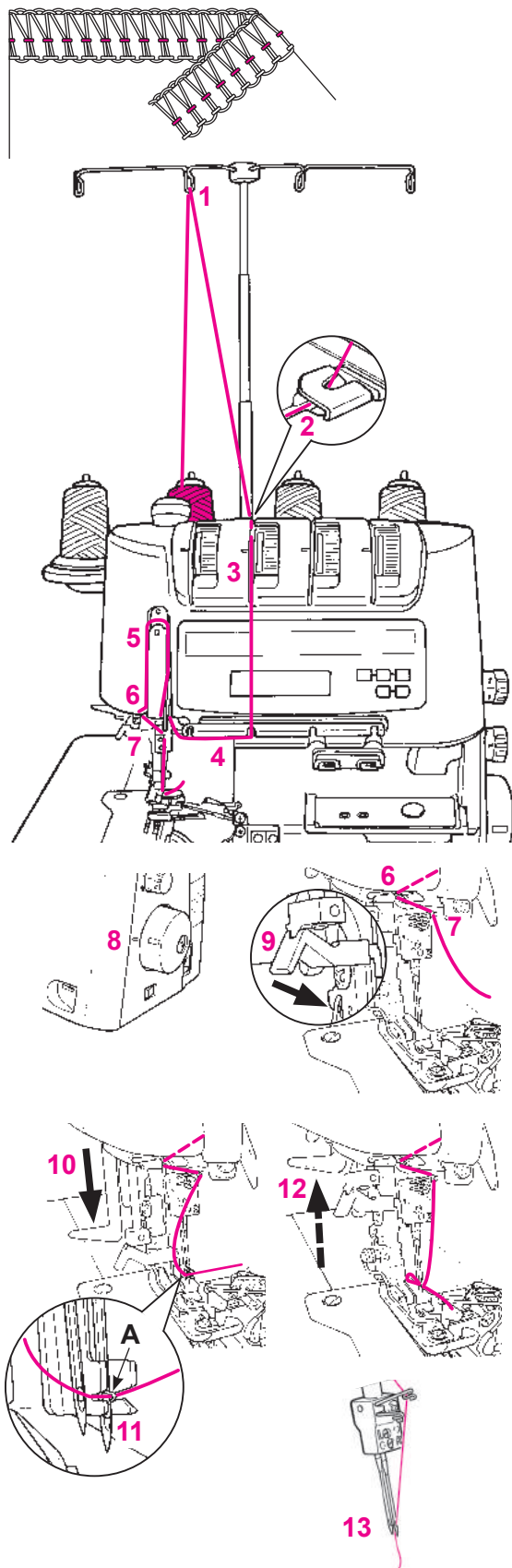

Right-hand needle, green markings



Switch the machine off (power switch "0")

Place the spool on the spool holder pin as illustrated.

- (1) Thread the thread guide which is located just above the spool from back to front.
- (2) Thread the thread guide No.1.
- (3) Route the thread in the groove.
- (4) Put the thread under the thread guide plate.
- (5) Thread the thread take-up cover (marked in green)
- (6) Thread the thread guide (right-hand side).
- (7) Thread the needle bar thread guide (right-hand side).
- (8) Turn the handwheel to align the "□" marking on it with the "—" marking on the side of the front cover.
- (9) Set the right-/left-needle changeover lever to the right needle side.
Be sure to move the right-/left-needle changeover lever to the right needle side until it will go no further.
- (10) Lower the threading lever as far as it goes.
- (11) Push the thread into section **A** with both hands.
- (12) The thread automatically passes through the needle eyelet by pushing the threading lever upward.
- (13) Pull out the thread by approximately 10 cm to route it under the presser foot and draw it out from its rear.

Threading 4/3 Thread OL

Left-hand needle, beige markings

	Switch the machine off (power switch "0")
--	--

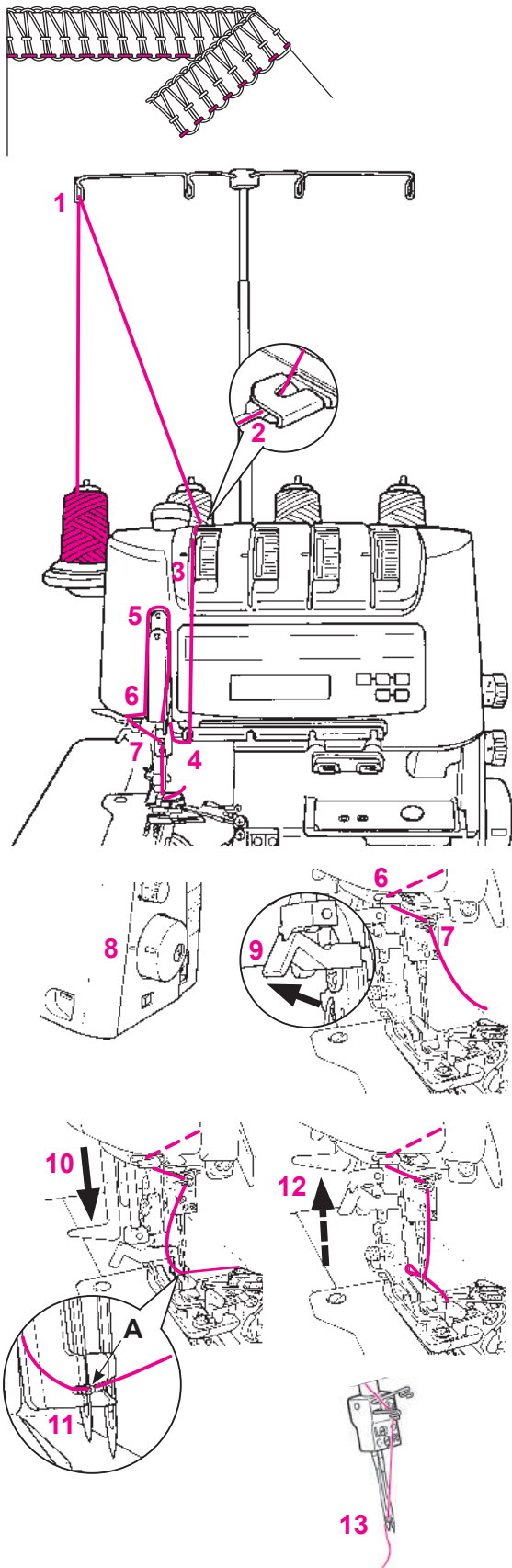

- Place the spool on the spool holder pin as illustrated.
- (1) Thread the thread guide which is located just above the spool from back to front.
 - (2) Thread the thread guide No.1
 - (3) Route the thread in the groove.
 - (4) Put the thread under the thread guide plate.
 - (5) Thread the thread take-up cover (marked in beige)
 - (6) Thread the thread guide (left-hand side).
 - (7) Thread the needle bar thread guide (left-hand side).
 - (8) Turn the handwheel to align the "□" marking on it with the "—" marking on the side of the front cover.
 - (9) Set the right-/left-needle changeover lever to the left needle side.
Be sure to move the right-/left-needle changeover lever to the left needle side until it will go no further.
 - (10) Lower the threading lever as far as it goes.
 - (11) Push the thread into section **A** with both hands.
 - (12) The thread automatically passes through the needle eyelet by pushing the threading lever upward.
 - (13) Pull out the thread by approximately 10 cm to route it under the presser foot and draw it out from its rear.

Threading 4/3 Thread OL

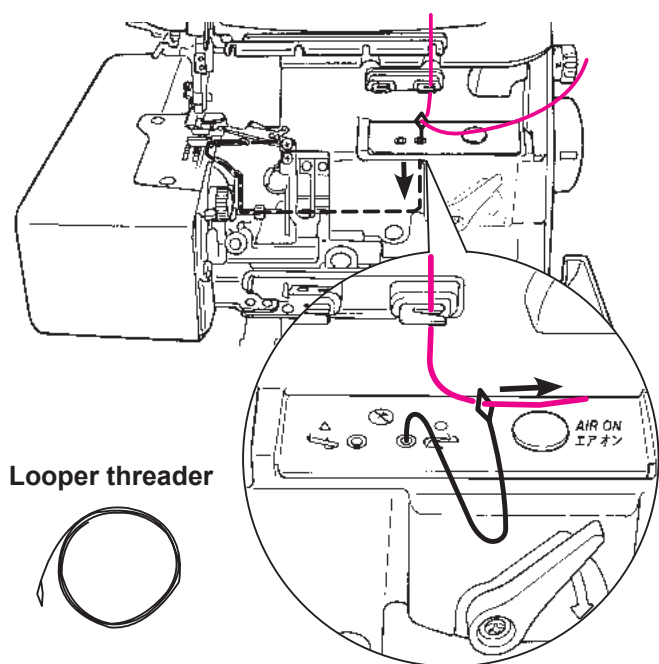

How to use the looper threader

To thread woolly thread or any thread that cannot pass smoothly through the threading holes, it is recommended either to use the "looper threader" supplied in the accessory bag, or to prepare an approximately 30 cm long spun thread or the like, tie it at the end of the woolly thread, pass the spun thread through the threading hole and pull it until the woolly thread passes through the hole.

(The looper threader can also be used as a cleaning tool for pipes.)

1. Raise the threading changeover lever in the direction of the arrow.

Turn the handwheel toward you until it clicks.

2. Pass the thread through the looper threader ring.

3. Pass the looper threader through the looper by hand until it comes out from the end of the looper.

Caution:

Do not press the air-control pushbutton.

Note:

If the upper or lower looper thread breaks during sewing, re-threading is necessary. Remove both the broken and unbroken looper threads. Then, set the threading lever to the threading side to carry out threading of the upper and lower loopers.

Caution:

After the completion of threading of the upper and lower loopers, return the threading lever to its home position. If not, the looper cover cannot be closed.

Trial sewing

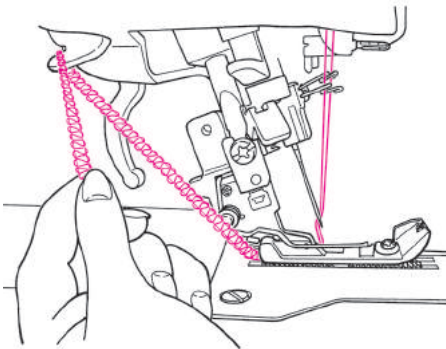
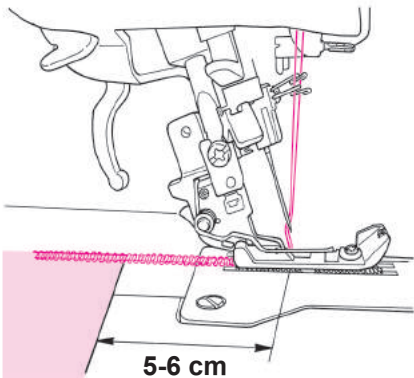
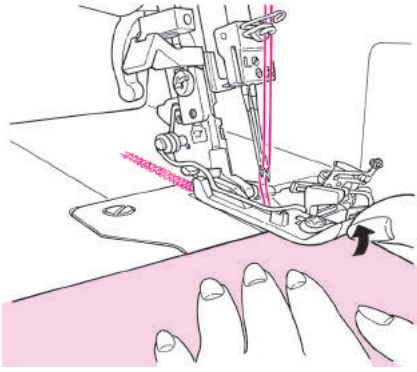

Sewing test

Use two plies of material to check that the quality of the finished seam and thread tensions are correct.

1. Close the looper cover. Turn the power on.
 2. Check that the upper knife is raised.
 3. Lower the presser foot.
 4. While holding the thread trailing from the rear of the presser foot by hand, depress the controller to produce chain-off thread by 6 to 7 cm.
 5. Raise the front side of the presser foot with fingers and insert the material under the presser foot until the upper knife is reached.
 6. Start the sewing machine.
 7. After the completion of sewing, produce chain-off thread by 5 to 6 cm.
 8. Put the chain-off thread over the thread trimming blade for trimming.
- * Chain-off thread is stitch-formed thread with no material.

Thread tension

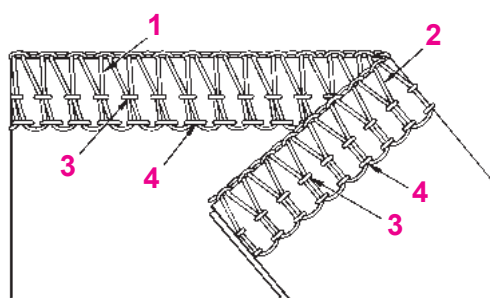

Check your trial run 4/3 Thread OL

1. Upper looper thread (purple).
2. Lower looper thread (red).
3. Right-hand needle thread (green).
4. Left-hand needle thread (beige).

Perfect stitch formation is when both looper threads meet at the fabric edge. The needle threads form straight stitches for a stretchy and durable seam.

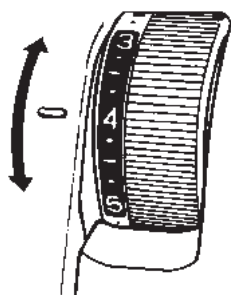

Thread tension

Thread tension should be properly adjusted to suit the various types of work.

The ideal tension setting for most fabrics and threads is between 3 and 5. However this can vary quite considerably when special threads such as filament, woolly nylon, buttonhole twist (cordonnet), pearl yarn or decorative threads are used. Only use decorative threads in the looper. The thread must move easily and without resistance through the looper eye.

Infinitely variable adjustments can be made from 1 - 9.

Turn the dial downwards for less tension.

Turn the dial upwards for more tension.

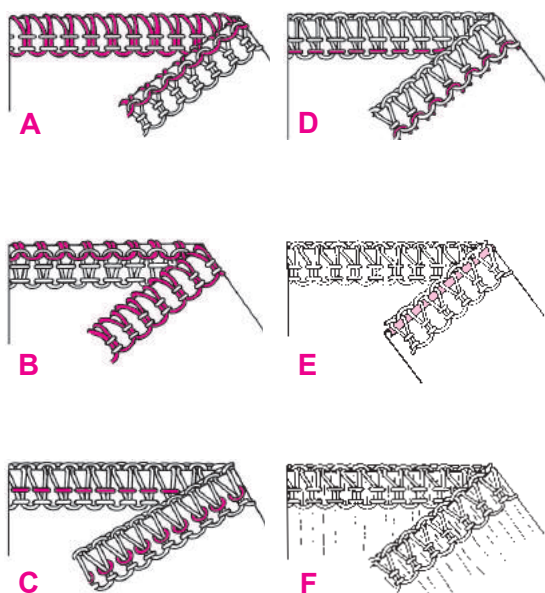

Adjusting the thread tension

Turn the tension dials by quarter or half number, then test sew again and check the result.

- The loops are formed on the underside.
Tighten the upper looper thread tension, (purple) or loosen the lower looper thread tension, red (A).
- The loops are formed on the upper side.
Tighten the lower looper thread tension, (red) or loosen the upper looper thread tension, purple (B).
- The right-hand needle thread forms loops on the underside.
Tighten the right-hand needle thread tension, green (C).
- The left-hand needle thread forms loops on the underside.
Tighten the left-hand needle thread tension, beige (D).
- The edge of the fabric curls up, tension of both looper threads is too tight:
Loosen upper and lower looper thread tensions, purple and red (E).
- The fabric puckers during sewing:
Loosen the right- or left-hand needle thread tension, green or beige (F).

Practical Sewing - Overlock

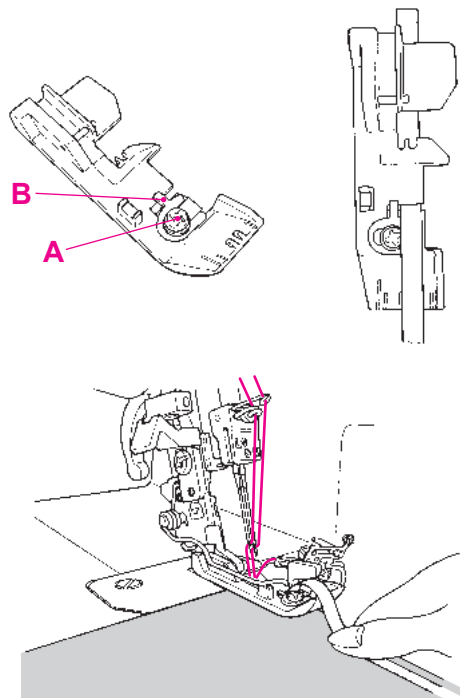

Sewing in tape

The standard presser foot is equipped with a tape guide. A tape can be sewn into the shoulder or side seams of garments made from knits or stretch fabrics to prevent stretching.

- Turn handwheel towards you until needles are fully raised. Match the matching up marks on handwheel and side cover.
- Raise the presser foot.
- Lay the tape under the presser foot and slide it carefully into the tape slot.
- Lower the presser foot.
- Sew a few stitches on the tape.
- Loosen the setscrew (A) and adjust the tape guide to suit the width of the tape (B).
- Re-tighten setscrew.
- Raise the tip of the presser foot and place work underneath. Sew.

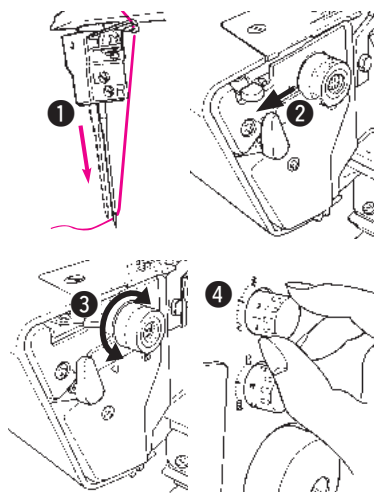

Carrying out hemming and narrow overlocking

The sewing machine incorporates the hemming device to enable roll hemming and narrow overlocking. The sewing machine is able to overlock the material edges such as bottoms and sleeve cuffs beautifully while automatically folding them inwardly.

Preparation for hemming

1. Install the right needle only.
2. Pull the overlocking width changeover knob toward you to lower the overlocking claw.
3. Set the lower knife adjusting knob at the scale mark "1 to 1.5".
4. When using filament thread or woolly nylon thread, set the stitch length adjustment dial (stitch length) at "1 to 1.5".

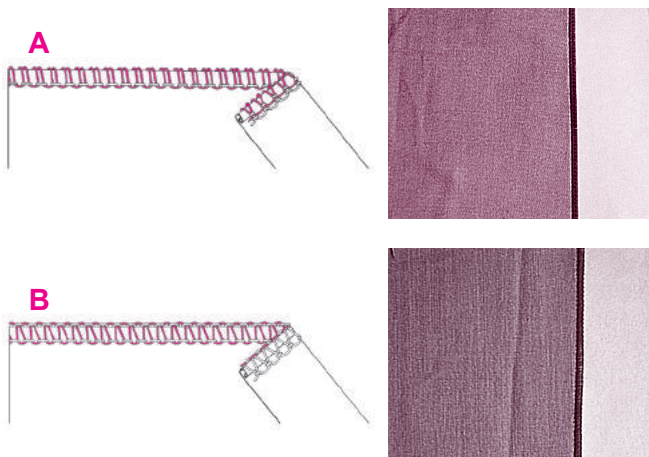

Roll hemming (A)

The roll hemming is the stitch system that laps the material edge with the upper looper thread.

Narrow overlocking (B)

The narrow overlocking is the overlock stitch system overlocking width of which is narrower than the standard one.

Practical Sewing - Overlock

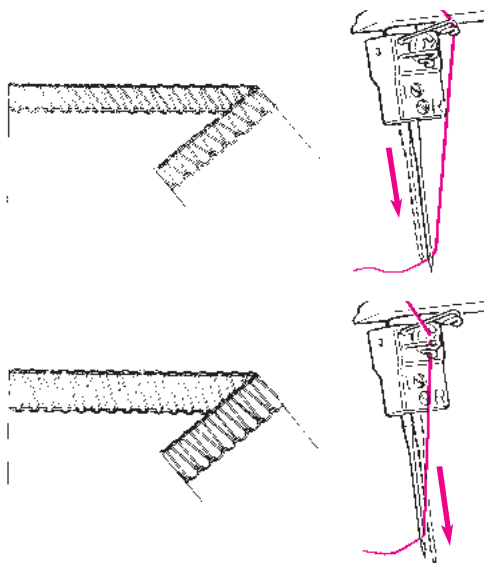

Wrapped overlocking with three threads

For wrapped overlocking with the right needle (3 to 7 mm in width)

1. Remove the left needle.
2. Thread the upper and lower loopers in the same manner as the standard sewing (2-needle, 4-thread).

For wrapped overlocking with the left needle (5 to 9 mm in width)

1. Remove the right needle.
2. Thread the upper and lower loopers in the same manner as the standard sewing (2-needle, 4-thread).

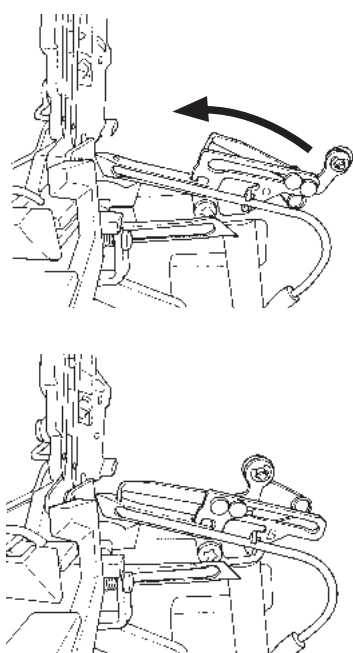

2-/3-thread changeover attachment

Use the 2-/3-thread changeover attachment when it is desired to carry out 2-needle overlocking, cover stitch (flatlock) or 2-thread hemming.

1. Turn off the power switch.
2. Press the 2-/3-thread changeover attachment mounted on the upper looper to the left.
3. Check that the projection of the 2-/3-thread changeover attachment is inserted into the hole in the top end of the looper.

In the aforementioned state, the upper looper thread is not fed. However, the lower looper thread is fed to form 2-thread stitches.

Practical Sewing - Overlock

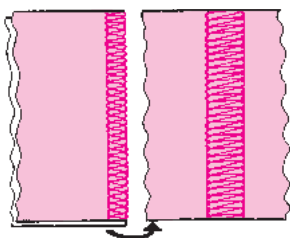
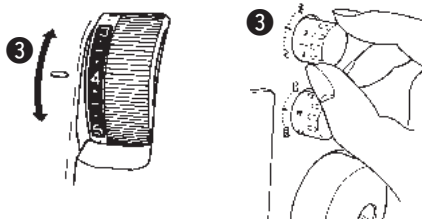
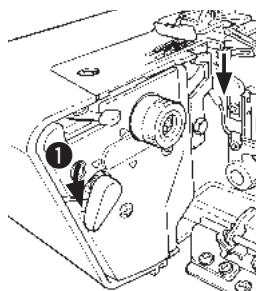
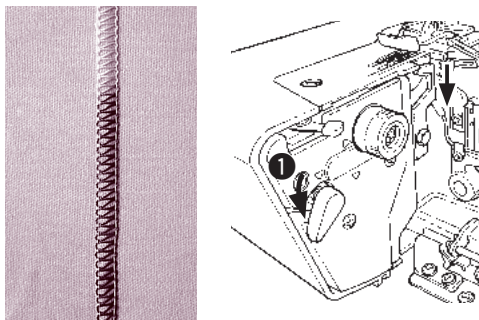

Cover stitch with three threads (flatlock)

1. Deactivate the upper knife.
2. Use a decorative thread as the upper looper thread. (Filament thread is best-suited as the needle thread and the lower looper thread. However, spun thread can also be used.)
3. Adjust the tension regulating dial and stitch length adjustment dial. Adjust the dials so that the thread tension is slightly reduced.

Scale mark of tension regulating dial	Thread tension of left or right needle	1 - 3
	Thread tension of upper looper	1 - 5
	Thread tension of lower looper	5 - 7
Stitch length adjustment dial		2 - 2.5

4. Use either the left needle or the right needle only.
In the case of the left needle: Wide cover stitches are sewn. (5 to 9 mm)
In the case of the right needle: Narrow cover stitches are sewn. (3 to 7 mm)
5. Fold the material in two. Carry out sewing with a preset overlocking width.
6. After the completion of sewing, unfold the material.

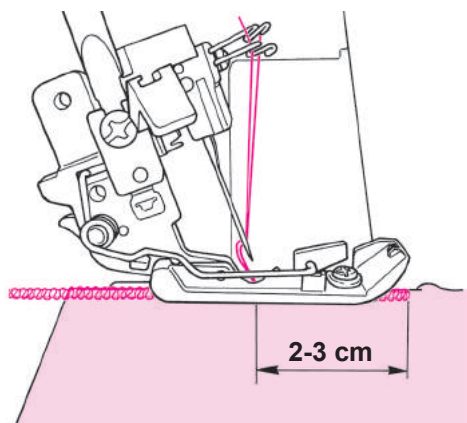

Thread breakage during sewing

Sew off immediately at an angle and remove the work. Re-thread.

If the upper or lower looper thread breaks during sewing, re-threading is necessary. Remove both the broken and unbroken looper threads. Then, set the threading lever to the threading side to carry out threading of the upper and lower loopers.

First thread the looper and then the needles.

Start sewing again about 2 - 3 cm in front of the break.

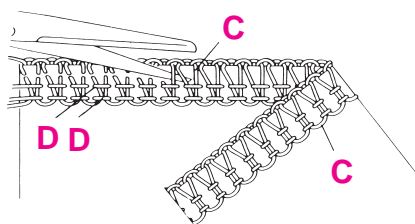

Unpicking seams

Using sharp scissors, cut the loops (C).

Pull the needle thread (D) and the stitches will come undone.

Practical Sewing - Overlock

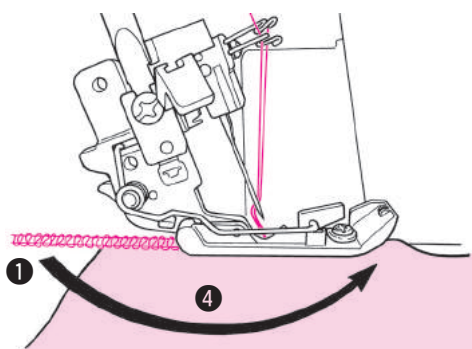

Securing thread ends at the beginning and end of sewing

Overlock stitches can unravel if the threads are not secured at the beginning and end of sewing. Secure the thread ends.

Securing thread ends with the overlock machine

1) Securing thread ends at the beginning of sewing

1. Pull out chain-off thread produced at the beginning of sewing by 3 to 4 cm.
 2. Sew the material by two or three stitches.
 3. Lower the needle and raise the presser foot.
 4. Stretch the chain-off thread to put it between the presser foot and the material from the left side.
 5. Lower the presser foot and sew the chain-off thread on the material.
- * If you do not sew the chain-off thread on the material, produce a longer chainoff thread at the beginning and end of sewing. Then, make a knot of the chainoff thread or put the chain-off thread under the seam with a wool needle.
- * When stitches cross each other, chain-off thread is automatically secured.

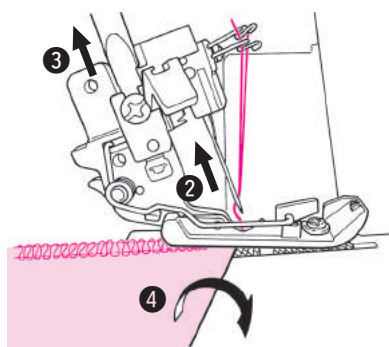

2) Securing thread ends at the end of sewing

1. Stop the needle at the end of material.
2. Lift the needle.
3. Raise the presser foot.
4. Turn the material upside down. Lower the needle so that it enters the outside edge of finished seam.
5. Lower the presser foot.
6. Carry out sewing to produce chain-off thread by 2 to 3 cm taking care not to allow the finished seam to come in contact with the upper knife. Remove the material.
7. Secure the chain-off thread.

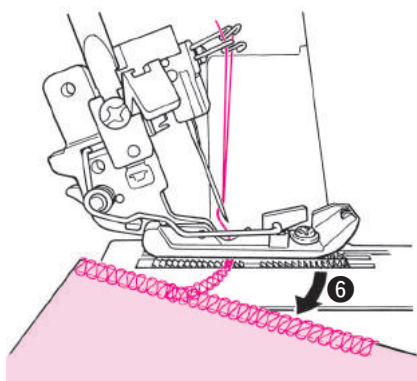

Practical Sewing - Overlock

A

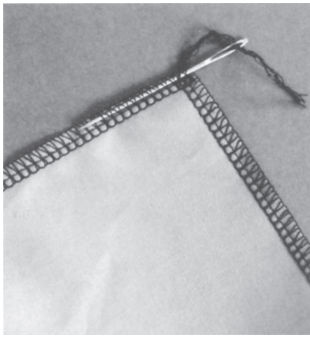

In the case of securing thread ends with a wool needle: (A)

Leave a 2 to 3 cm long chain-off thread at the beginning and end of sewing. Put the chain-off threads in the finished seam by means of a wool needle.

B

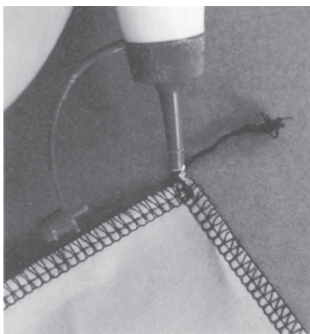

In the case of securing thread ends with glue for handcraft: (B)

Apply a little amount of glue for handcraft at the root of chain-off thread on the material. Cut out the excess of chain-off thread after the glue has dried.

C

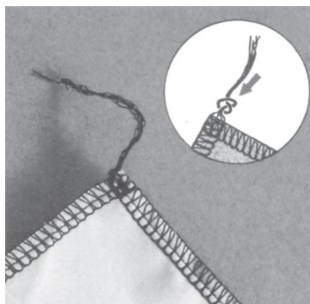

Securing thread ends by making a knot: (C)

Bind all threads together and make a knot at the nearest position of the material. Then, cut out the excess of the threads.

LCD indication

Set values of 15 different kinds of stitch can be visually checked on the LCD screen. In addition, three different set values can be added to the current set value. (Memory number)

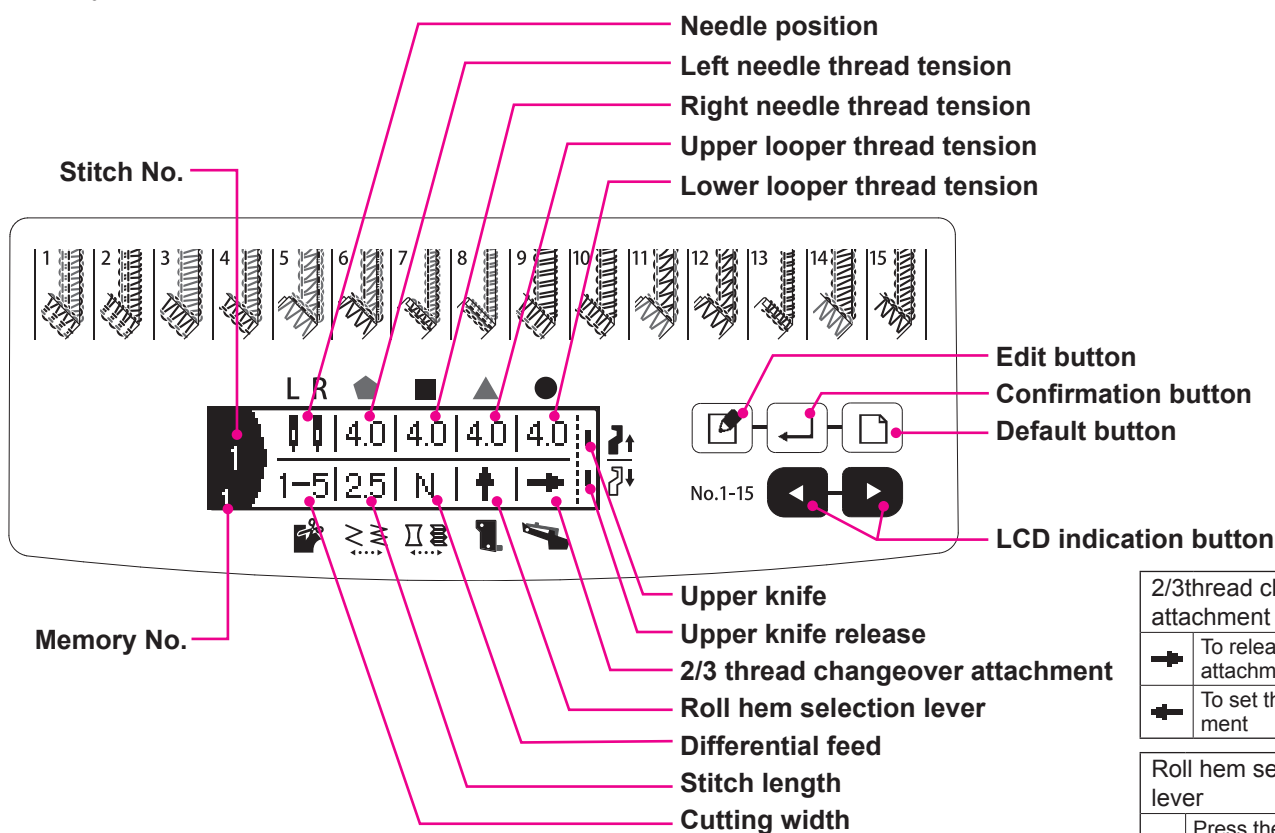

2/3thread changeover attachment	
→	To release the attachment
←	To set the attachment

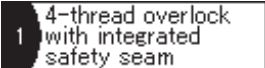
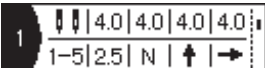
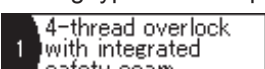
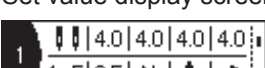
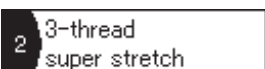
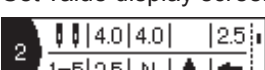

Roll hem selection lever	
↑	Press the lever away from you to let the roll hemming claw come out.
↓	Pull the lever toward you to lower the roll hemming claw.

1. Basic method of use





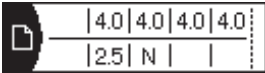





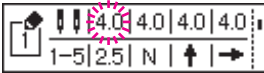

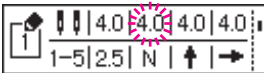
No.	Operation	Display	Remarks
1	When the power is turned ON	"Welcome" display 	You can select language from 9 languages. Refer to page 32. (Default setting is English.)
2	4 seconds later	Sewing type name display screen  Set value display screen 	The screen which was displayed at the last time when the power was turned OFF.
3	When [Confirmation] is pressed	Sewing type name display screen  Set value display screen 	The screen is changed over between the sewing type name display screen and the set value display screen.
4	When [Edit] or [Default] is pressed	Sewing type name display screen  Set value display screen 	Select the stitch type. Select the set value.

2. How to display the initial value





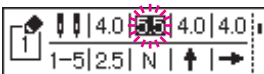

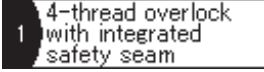
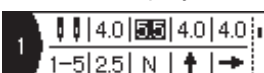
* The initial value is the default value which has been factory-set at the time of shipment.

No.	Operation	Display	Remarks
1	When  is pressed	Initial value display screen 	The initial value of the selected stitch type is displayed. The initial value is displayed as long as  is held pressed.

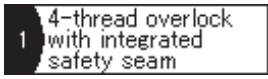
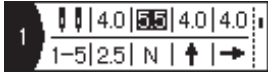
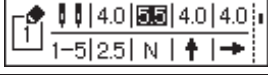
3. How to edit the set value

No.	Operation	Display	Remarks
1	When  is pressed	Edit item selection screen 	Display of selected item flashes on and off.
2	When  or  is pressed	Edit item selection screen 	Select the item you want to edit.
3	When  is pressed	Edit screen 	
4-a	When  or  is pressed	Edit screen 	The value is set.
4-b	When  is pressed	Edit screen 	The value returns to the initial value.
5	When  is pressed	Edit item selection screen 	The value is stored in memory and the screen returns to the edit item selection screen. If the value differs from the initial value, the relevant item is highlighted.
6	When  is pressed	Sewing type name display screen  Set value display screen 	The screen returns to the previous screen.

4. How to initialize the set value

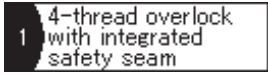
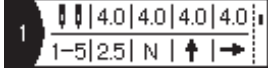
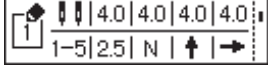
No.	Operation	Display	Remarks
1		Sewing type name display screen  Set value display screen  Edit item selection screen 	Display the stitch pattern you want to initialize.
2	Press  while keeping  held pressed.	Initialization check screen 	
3	When one of them is pressed:  : Initialize  : Cancel	Sewing type name display screen  Set value display screen  Edit item selection screen 	The set value is initialized and the screen returns to the previous screen.

5. How to use the memory number

The memory number is the function for increasing the number of set value display screens.

For each of 15 stitch patterns, three memory numbers can be added to the current set value at the maximum.





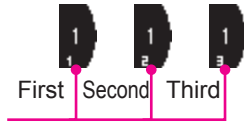

Example)

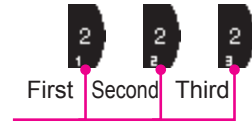
The current set value of “Stitch pattern 1” can be changed to three different set values.

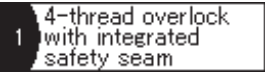
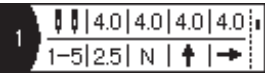

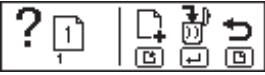



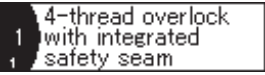
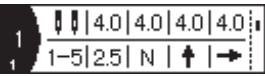









The current set value of “Stitch pattern 2” can be changed to three different set values.



No.	Operation	Display	Remarks
1		Sewing type name display screen  Set value display screen 	Display the stitch pattern you want to add or delete.
2	Keep  held pressed for two seconds.	Memory check screen 	Caution: If there are already three or more memory numbers, no more one can be added. In the case the stitch pattern selected is not a memory number, it can not be deleted.
3	When one of the following is pressed:  : Add  : Delete  : Cancel	Sewing type name display screen  Set value display screen 	Addition or deletion of the memory number is executed and the screen returns to the previous screen.

6. How to set the language and the LCD contrast

No.	Operation	Display	Remarks
1	When the power is turned ON while keeping  and  held pressed	Language selection screen 	The currently-selected language is displayed.
2	When  or  is pressed	Language selection screen 	Select the language.
3	When  is pressed	LCD contrast adjustment screen 	
4-a	When  or  is pressed	LCD contrast adjustment screen 	Set the contrast.
4-b	When  is pressed	LCD contrast adjustment screen 	The contrast returns to the initial value.
5	When  is pressed	“Welcome” display 	

Stitch chart

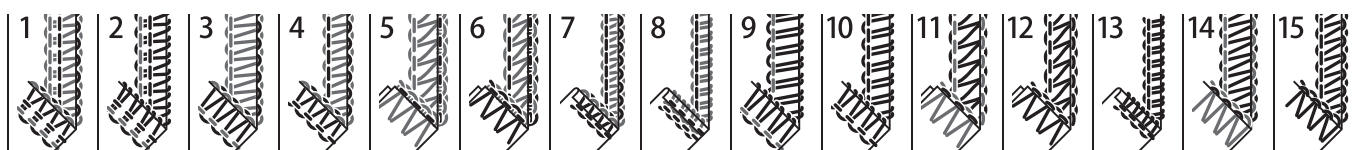

* The scale marks of the tension regulating dial listed below are just a guide. The correct adjustment differs according to the type of thread and material to be used.

	Stitch No.	Stitch	Needle position		Thread tension				Cutting width	Stitch length	Differential feed	Roll hem selection lever	2/3 thread change-over attachment	Upper knife
					Left needle	Right needle	Upper looper	Lower looper						
					L	R	⬠	■						
4-Thread / 3-Thread	1	4-Thread overlock with integrated safety seam	⬇	⬇	4.0	4.0	4.0	4.0	1-5	2.5	N	↑	→	⬆↑
	2	3-Thread super stretch	⬇	⬇	4.0	4.0	---	2.5	1-5	2.5	N	↑	←	⬆↑
	3	3-Thread overlock (left needle)	⬇	-	4.0	---	4.0	4.0	1-5	2.5	N	↑	→	⬆↑
	4	3-Thread overlock (right needle)	-	⬇	---	4.0	4.0	4.0	1-5	2.5	N	↑	→	⬆↑
	5	3-Thread Flatlock (left needle)	⬇	-	1.0	---	3.0	6.0	---	2.5	N	↑	→	⬆↓
	6	3-Thread Flatlock (right needle)	-	⬇	---	1.0	3.5	6.0	---	2.5	N	↑	→	⬆↓
	7	3-Thread narrow seam	-	⬇	---	4.5	4.0	5.0	1.0	1.0	N	↓	→	⬆↑
	8	3-Thread roll hem	-	⬇	---	4.0	3.5	6.0	1.0	1.0	N	↓	→	⬆↑
2-Thread	9	2-Thread wrapped overlock (left needle)	⬇	-	5.0	---	---	3.5	1-5	2.5	N	↑	←	⬆↑
	10	2-Thread wrapped overlock (right needle)	-	⬇	---	4.5	---	3.0	1-5	2.5	N	↑	←	⬆↑
	11	2-Thread Flatlock (left needle)	⬇	-	2.0	---	---	4.0	---	2.5	N	↑	←	⬆↓
	12	2-Thread Flatlock (right needle)	-	⬇	---	3.0	---	5.5	---	2.5	N	↑	←	⬆↓
	13	2-Thread roll hem	-	⬇	---	4.0	---	5.0	1.0	1.0	N	↓	←	⬆↑
	14	2-Thread overlock (left needle)	⬇	-	2.0	---	---	5.0	1-5	2.5	N	↑	←	⬆↑
	15	2-Thread overlock (right needle)	-	⬇	---	2.5	---	6.5	1-5	2.5	N	↑	←	⬆↑

Maintenance

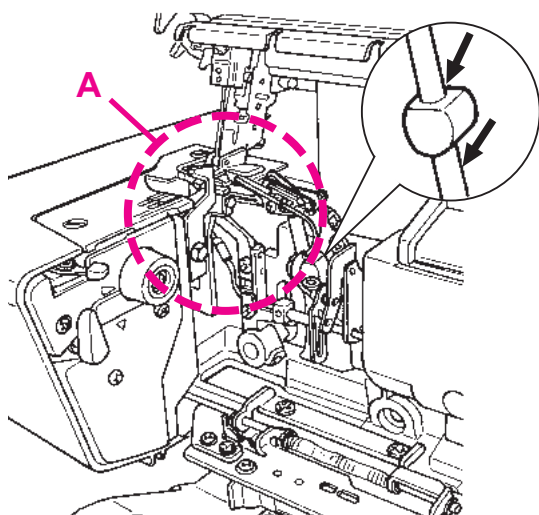

Cleaning and lubricating



Turn off the power switch and disconnect the power plug from the wall outlet before starting cleaning or lubricating the machine.

As you use the sewing machine, lint is likely to accumulate in the sewing machine. It is necessary to remove the lint periodically. Since lint accumulates particularly in the sections around the throat plate and lower knife, remove the lint from those sections on a periodical basis. (A)

When cleaning the pipes of the upper and lower loopers, use the “looper threader” supplied in the accessory bag. (Refer to page 21 for how to use it.)

The sewing machine uses special materials for important parts. Apply one or two drops of machine oil to the sections illustrated.

Precautions to be taken when handling oil

- * In the event the oil gets in the eye or adheres on skin, immediately wash it off in order to prevent irritation and rash.
- * If swallowed accidentally, immediately seek for medical advice in order to prevent diarrhea and vomiting.
- * Keep the oil away from children.
- * Oil disposal is obliged by legislation. Dispose of the oil properly in compliance with the relevant legislation.

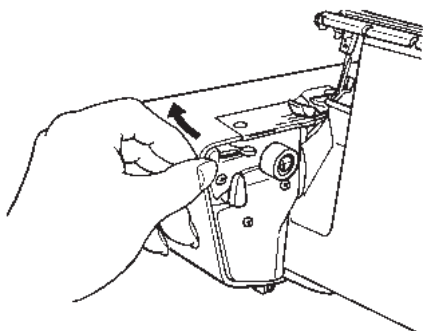

To carry out cleaning with the cloth plate opened



Be sure to turn off the power switch before opening the cloth plate.

• How to open the cloth plate

Push this side of the cloth plate to the left to open it.

• How to close the cloth plate

Push the cloth plate toward the sewing machine.

Replacing the knife

It is not normally necessary to replace the lower knife since it is made of special ultrahard material. If the knife blade tip has chipped, replace the knife with a new one.

Contact your distributor for the replacement of the lower and upper knives.

Trouble shooting guide

Problem	Cause	Solution	Page
The machine does not sew:	• Looper or cloth plate cover is open.	• Close the looper or the cloth plate cover.	9
	• The main switch is not on.	• Switch machine on. (Main switch to "I")	9
	• The machine is not plugged in.	• Insert plug into main socket.	7
Fabric does not feed evenly	• Differential feed is wrongly adjusted.	• Check the differential feed setting.	14
	• Presser foot pressure is too low.	• Adjust the presser foot pressure.	15
Thread breaks	• Thread tension is too tight for the thread being used.	• Reduce thread tension.	23
	• The machine is not threaded correctly.	• Check the threading.	17
	• Needles are incorrectly inserted.	• Insert needles fully into needle clamp with flat side to the back.	11
	• Wrong needles.	• Use needle system 130/705H or JLx2.	11
Needles break	• Needles are bent or blunt, points are damaged.	• Replace needles.	12
	• Needles are not inserted correctly.	• Insert needles fully into needle clamp with flat side to the back.	11
	• Fabric was pulled while sewing.	• Guide fabric gently with both hands.	--
Skipped stitches	• Needles are bent or blunt.	• Replace the needles.	11
	• Wrong needles used.	• Use needle system 130/705H or JLx2.	11
	• Presser foot pressure is too low.	• Increase presser foot pressure.	15
Poor stitch formation	• Threads are not correctly between the tension dials.	• Check if thread is lying between tension discs.	16
		• Raise the presser foot and pull the thread.	16
	• Thread has got caught.	• Check threading path of each thread.	17
	• Machine is incorrectly threaded.	• Check threading path of each thread.	17
Seams flute or wave, especially when sewing knits	• Fabric was pulled while sewing.	• Guide fabric gently.	--
	• Presser foot pressure is too tight.	• Reduce presser foot pressure.	15
	• Differential feed is set incorrectly.	• Adjust differential feed to N - 2.	14
Seams pucker	• Needle thread tension is too tight.	• Reduce the needle thread tension.	23
	• Differential feed is set incorrectly.	• Adjust differential feed to 0.7 - N.	14
Fabric edges curl	• Too much fabric is in the stitch.	• Reduce cutting width.	13
	• Thread tension is too tight.	• Reduce thread tension.	23
	• Stitch selection lever is on roll hem.	• Set selection lever to overlock.	15

Problem	Cause	Solution	Page
Thread loops are too loose	<ul style="list-style-type: none"> • Too little fabric in the stitch. 	<ul style="list-style-type: none"> • Increase the cutting width. 	13
Motor failure	<ul style="list-style-type: none"> • Noise is heard. • Motor does not turn at all. • Sparks are abnormally large. 	<ul style="list-style-type: none"> • Replace the carbon brush with a new one. <p>(Note) Contact your distributor to ask for the replacement of the carbon brush.</p>	--
Needle eyelet cannot be threaded	<ul style="list-style-type: none"> • The “■” marking on the side of the front cover is not aligned with the “□” marking on the handwheel. 	<ul style="list-style-type: none"> • Turn the handwheel to align the “□” marking on it with the “■” marking on the side of the front cover. 	19,20
Upper and lower loopers cannot be threaded	<ul style="list-style-type: none"> • When the handwheel is not fixed. • When the thread is not inserted into the bottom of the threading hole. • When the thread is not slacked before the threading hole. • When the thread is caught somewhere in the thread path. • When the pipe is clogged with lint. 	<ul style="list-style-type: none"> • Raise the threading changeover lever and turn the handwheel to fix it. • Insert the thread into the threading hole by 1 to 2 cm. • Slack the thread before the threading hole. • Remove the thread from the location where it has been caught. • Thread the loopers by means of the looper threader supplied in the accessory bag to remove the lint in the pipe. 	17,18 17,18 17,18 -- 21

Technical data

Stitch choice	Over lock	2 needles, 2 loopers: 4 thread overlock with integrated safety seam 1 needle, 2 loopers: 3 thread overlock, flatlock roll hem 1 needle, 1 looper: 2 thread overlock, flatlock roll hem 2 needles, 1 looper: 3 thread super stretch
Needle system		SCHMETZ 130/705 H or JLx2
Seam width		5-7 mm (3/2 thread overlock) 7-9 mm (4 thread overlock / 3/2 thread overlock / 3 thread super stretch)
Stitch length		1-4 mm
Differential feed		No puckering 0.7 - N No waving or fluting in knits N - 2
Presser foot lifter		5 mm
Handwheel		Rotates forwards
Sewing speed		Up to 1,500 sti/min
Weight		9 kg
Dimensions		330 (W) × 280 (D) × 310 (H) mm
Foot control model No.		YC-482 (USA and Canada only) YC-483N (220-240V)

We reserve the right to make changes in the interest of technical progress.

Optional Accessories

- **Blind stitch presser foot**

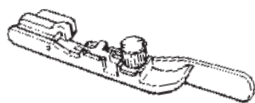

- **Piping presser foot**

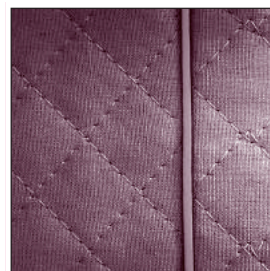
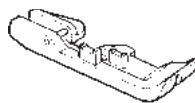

- **Elasticator**

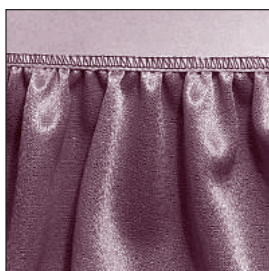
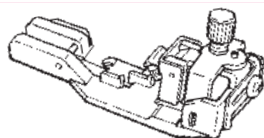

- **Beading presser foot**

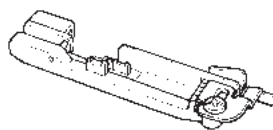

- **Cording presser foot**

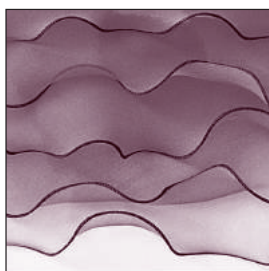
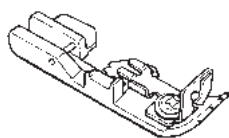

- **Gathering presser foot**

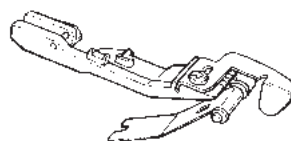

Contact your local dealer.

JUKI®

JUKI CORPORATION

2-11-1, TSURUMAKI, TAMA-SHI,
TOKYO, 206-8551, JAPAN

PHONE : (81)42-357-2341

FAX : (81)42-357-2379

Copyright © 2015 JUKI CORPORATION
All rights reserved throughout the world.

